

2a

1a

3

UPPER FRONT
PIECE SUPERIEURE DEVANT
DELANTERO SUPERIOR



1 x DANS LA PLIURE DU TISSU
CON CANTO DOBLADO

ON THE FOLD

5/8"
(1.5cm)

SEAM ALLOWANCE INCLUDED
AVEC VALEUR DE COUTURE
CON MARGEN DE COSTURA

6004

STRAIGHT GRAIN
DROIT FIL
SENTIDO HILO

Burda STYLE

www.burdastyle.com



2b

1a

1b

KEY TO SYMBOLS
LEGENDE
INTERPRETACION DE LOS SIMBOLOS



SYMBOL FOR STITCHING LINES
REMARQUE CONCERNANT LES LIGNES DE PIQUES
INDICACION PARA LINEAS DE PESPUNTE



SEAM ATTACHMENT POINT
POINT DE RACCORD DE LA COUTURE
PUNTO DE AJUSTE DE LA COSTURA



SEAM NUMBERS ARE MATCHING SYMBOLS AND DENOTE
WHERE TWO PIECES SHOULD BE SEWN TOGETHER.
LES CHIFFRES-REPERES INDIQUENT OU ASSEMBLER LES PIECES.
LES CHIFFRES IDENTIQUES COINCIDENT.
LOS NUMEROS DE COSTURA INDICAN DONDE LAS PIEZAS.
LOS MISMOS NUMEROS CONCIDEN.



GATHER BETWEEN THE STARS.
FRONCER ENTRE LES ASTERISQUES.
EMBEBER ENTRE LAS ESTRELLAS.



EASE IN BETWEEN THE DOTS.
SOUTENIR ENTRE LES POINTS.
EMBEBER ENTRE LOS PUNTOS.

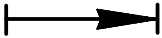

POSITION PLEATS IN DIRECTION OF ARROW.
POSER LES PLIS DANS LE SENS DES FLECHES.
PONER LOS PLIEQUES SEGUN LA FLECHA.



SYMBOL INDICATING THE BEGINNING OR END OF VENT.
REPERE DE DEBUT OU DE FIN DE FENTE.
MARCA PARA EL PRINCIPIO O FINAL DE LA ABERTURA.



SLASH
FENTE
CORTE



BUTTONHOLE
BOUTONNIERE
OIAL



BUTTON OR SNAP
BOUTON OU BOUTON-PRESSION
BOTON O BROCHE DE PRESION

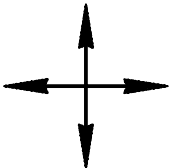

SEE CUTTING DIAGRAMS FOR STRAIGHT GRAIN OF FABRIC
SENS DU DROIT-FIL VOIR LES PLANS DE COUPE
DIRECCION DEL HILO, VEANSE PLANOS DE CORTE

STRAIGHT GRAIN
DROIT FIL
SENTIDO HILO



2c



1b



1c

LENGTHEN OR SHORTEN HERE
RALLONGER OU RACCOURCIR ICI
ALARGAR O ACORTAR AQUI

CENTER FRONT FOLD, STRAIGHT GRAIN
MILIEU DEVANT PLIURE, DROIT FIL
MEDIO DELANTERO DOBLEZ SENT.HILO

2d

LENGTHEN OR SHORTEN HERE
RALLONGER OU RACCOURCIR ICI
ALARGAR O ACORTAR AQUI

1c

1d

WAIST
TAILLE
CINTURA

STRAIGHT GRAIN
DROIT FIL
SENTIDO HILO

2e

46
44
42
40
38
36
34
FRUNCIR
FRONCER
GATHER

1d

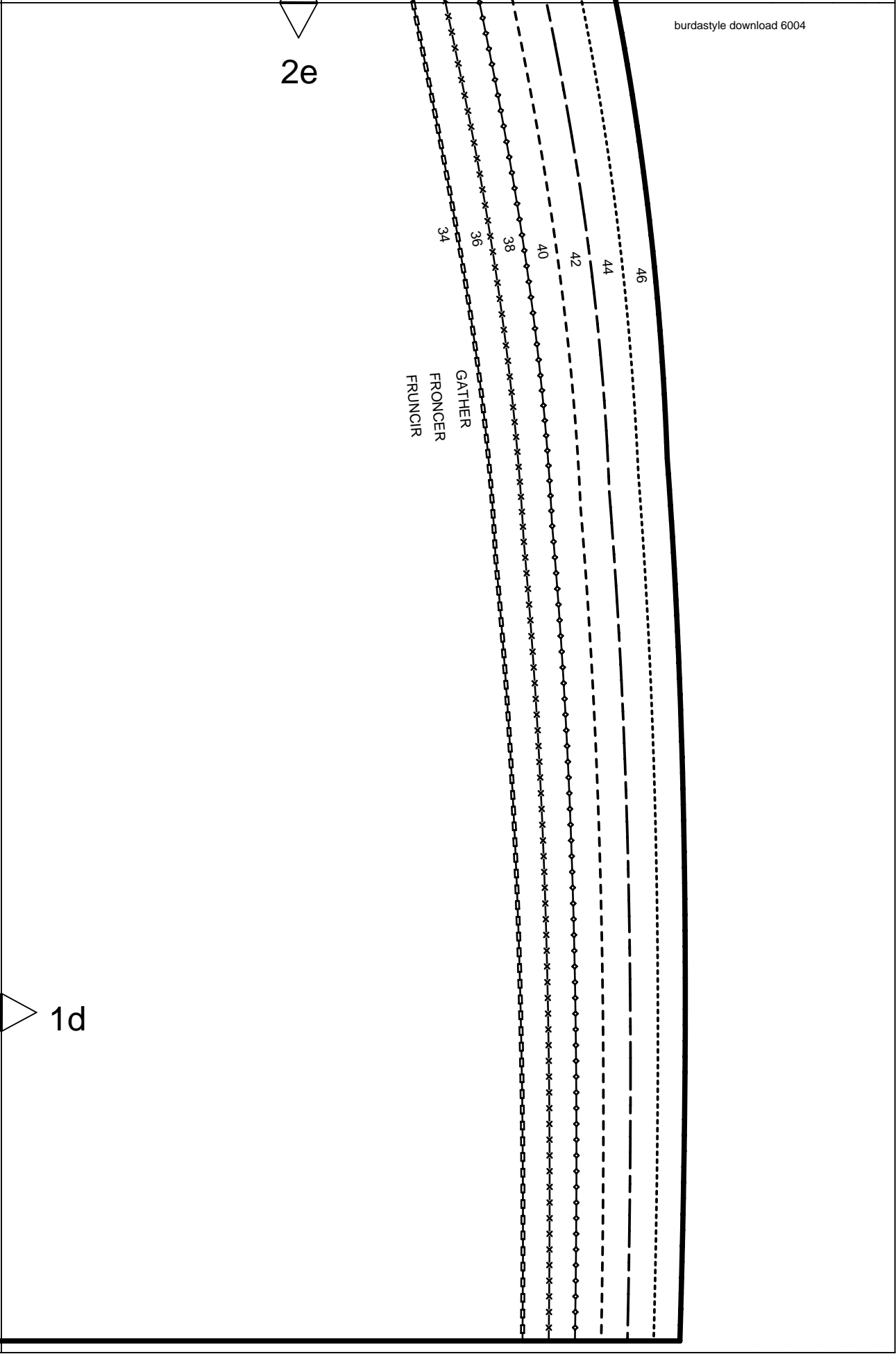

4a

STRAIGHT GRAIN
DROIT FIL
SENTIDO HILO

46

44

42

40

38

36

34

3a

2a

WAIST

TAILLE

CINTURA

4b

STRAIGHT GRAIN
DROIT FIL
SENTIDO HILO

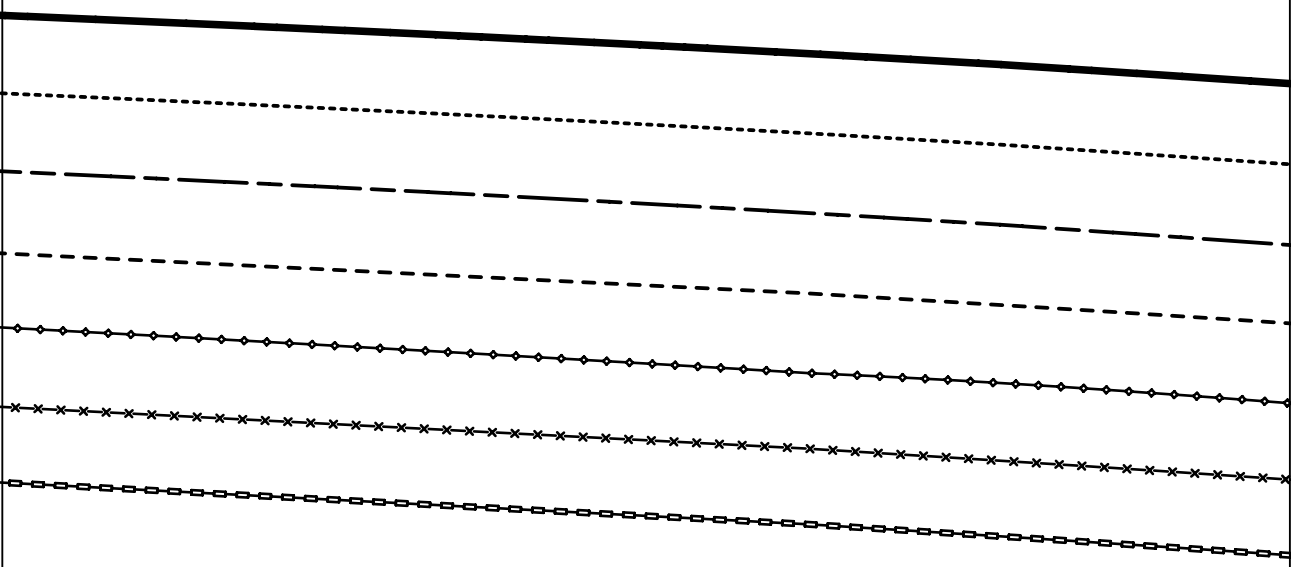

3b

3a

2b

4c

CENTER BACK FOLD STRAIGHT GRAIN
PLIURE DU TISSU MILIEU DOS DROIT FIL
CENTRO POSTERIOR DOBLEZ DIR.HILO

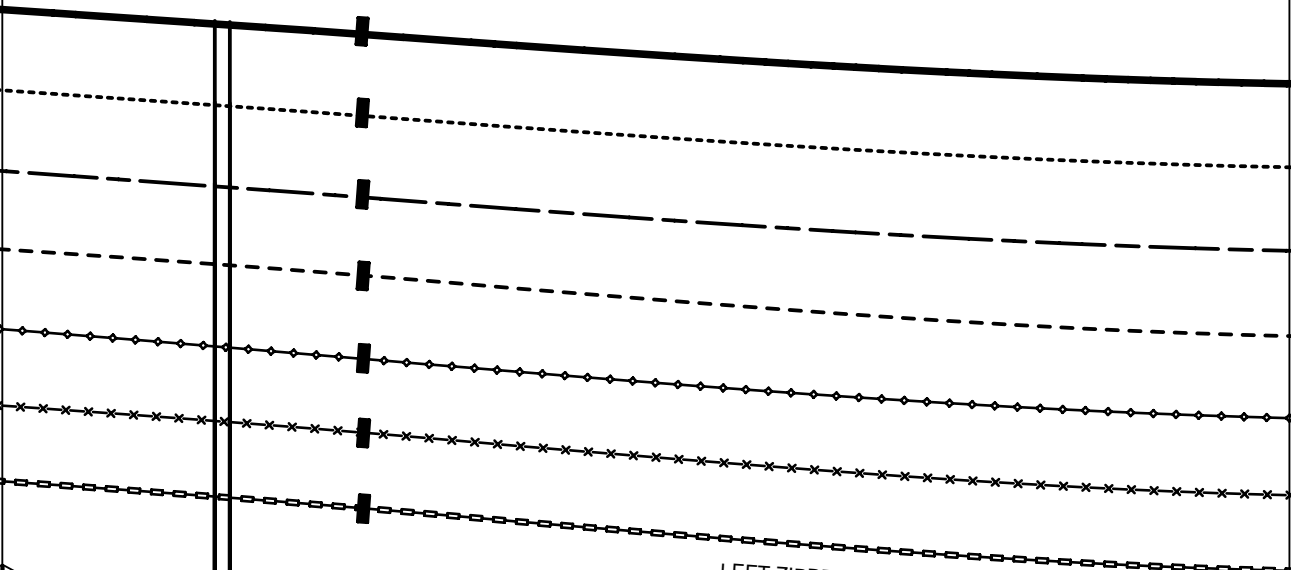

3b

LEFT ZIPPER
FERM. A GLISS A GAUCHE
CREMALLERA IZQUIERDA

3c

2c

4d

3d

STRAIGHT GRAIN
DROIT FIL
SENIDO HILO

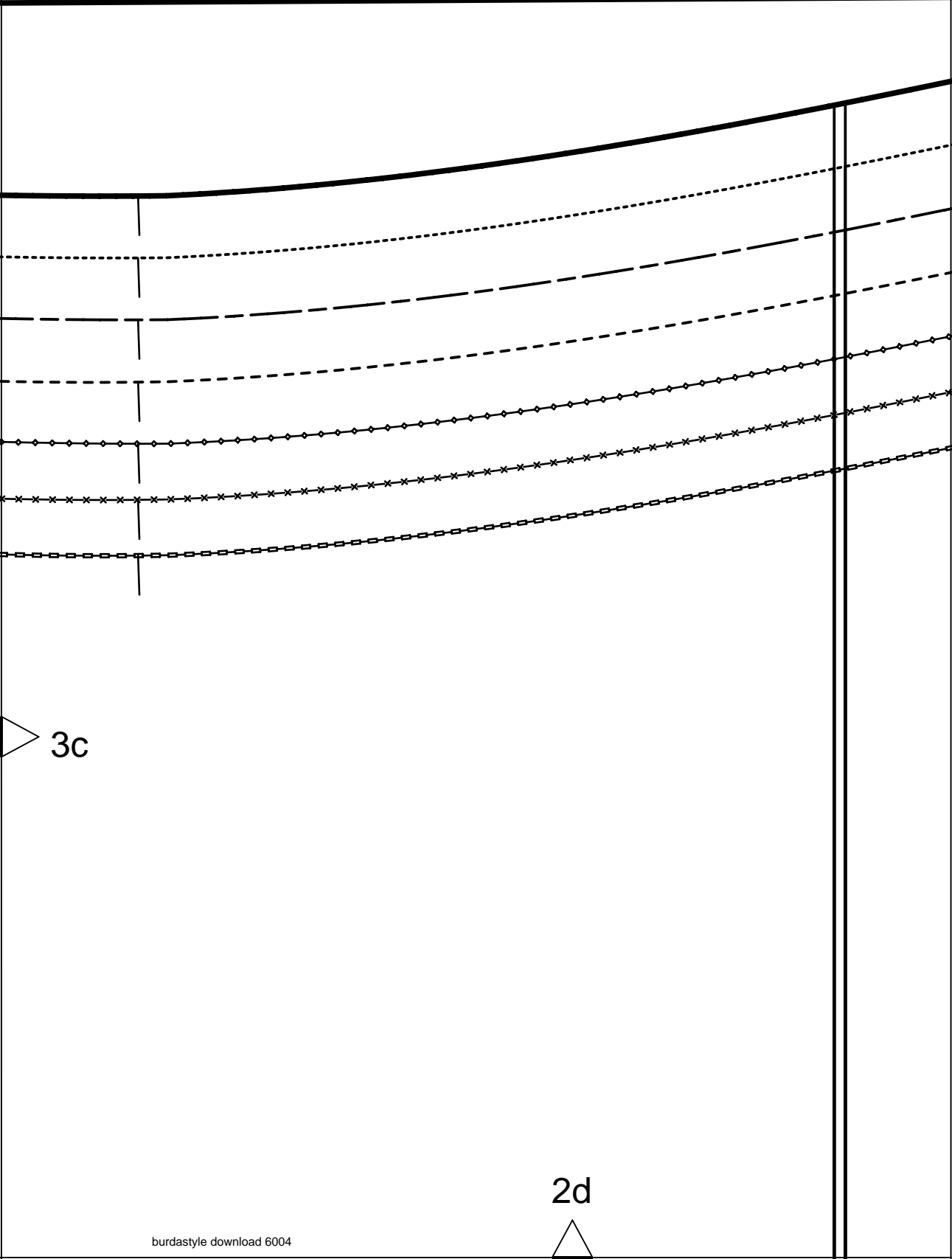

2d



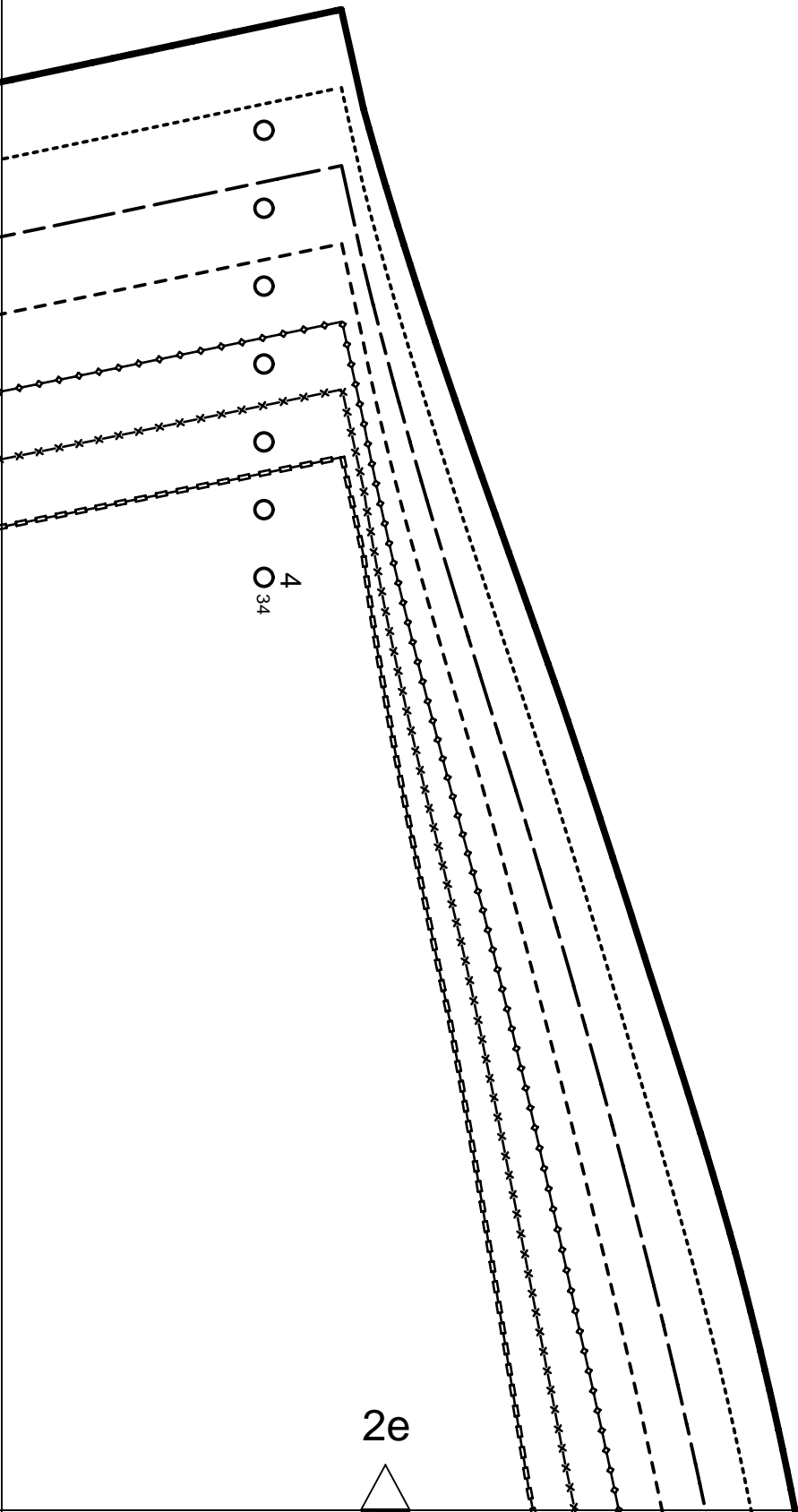

2e



GATHER
FRONCER
FRUNCIR

6a

LENGTHEN OR SHORTEN HERE
RALLONGER OU RACCOURCIR ICI
ALARGAR O ACORTAR AQUI

4a

5a

6b

5a

6

UPPER BACK
PIECE SUPERIEURE DOS
ESPALDA SUPERIOR

ON THE FOLD

DANS LA PLIURE DU TISSU
CON CANTO DOBLADO



5/8"
(1,5cm)

SEAM ALLOWANCE INCLUDED
AVEC VALEUR DE COUTURE
CON MARGEN DE COSTURA

6004

Burda
STYLE

www.burdastyle.com

5b

4b

6c

5c

LENGTHEN OR SHORTEN HERE
RALLONGER OU RACCOURCIR ICI
ALARGAR O ACORTAR AQUÍ

5b

4c

5c

6d

5d

Size Taille Talla		32	34	36	38	40	42	44	46	48	50	52	54	56	58	60
1	inches	66 1/4	66 1/4	66 1/4	66 1/4	66 1/4	66 1/4	66 1/4	66 1/4	66 1/4	66 1/4	66 1/4	66 1/4	66 1/4	66 1/4	66 1/4
	cm	168	168	168	168	168	168	168	168	168	168	168	168	168	168	168
2	inches	30	31 1/2	33	34 3/4	36 1/4	37 3/4	39 1/2	41	43 1/2	45 1/2	48	50 1/2	52 3/4	55 1/4	57 1/2
	cm	76	80	84	88	92	96	100	104	110	116	122	128	134	140	146
3	inches	23	24 1/2	26	27 3/4	29 1/4	30 3/4	32 1/2	34	36 1/4	38 3/4	41	43 1/2	45 1/2	48	50 1/2
	cm	58	62	66	70	74	78	82	86	92	98	104	110	116	122	128
4	inches	32 1/2	34	35 1/2	37	38 3/4	40 1/4	41 3/4	43 1/2	45 1/2	48	50 1/2	52 3/4	55 1/4	57 1/2	60
	cm	82	86	90	94	98	102	106	110	116	122	128	134	140	146	152
5	inches	15 3/4	16	16 1/4	16 1/2	16 1/2	16 3/4	17	17 1/4	17 1/4	17 1/2	17 3/4	18	18 1/4	18 1/2	18 1/2
	cm	40	40,5	41	41,5	42	42,5	43	43,5	44	44,5	45	45,5	46	46,5	47
6	inches	23 1/4	23 1/4	23 1/4	23 3/4	23 3/4	24	24	24	24	24 1/2	24 1/2	24 1/2	24 3/4	24 3/4	24 3/4
	cm	59	59	59	60	60	61	61	61	61	62	62	62	63	63	63
7	inches	13	13 1/2	14 1/4	14 1/2	14 3/4	15	15 1/2	15 3/4	16 1/4	16 1/2	17	17 1/4	17 3/4	18 1/4	18 1/2
	cm	33	34	35	36	37	38	39	40	41	42	43	44	45	46	47
8	inches	39 3/4	40 1/4	40 1/4	40 3/4	41	41	41 1/2	41 1/2	41 1/2	41 3/4	41 3/4	41 3/4	42 1/4	42 1/2	42 1/2
	cm	101	102	102	103	104	104	105	105	105	106	106	106	107	108	108
9	inches	16 1/2	17	17 1/4	17 3/4	18 1/4	18 1/2	19	19 1/4	19 3/4	20 1/4	20 1/2	21	21 1/4	21 3/4	22 1/4
	cm	42	43	44	45	46	47	48	49	50	51	52	53	54	55	56
10	inches	9 1/2	9 7/8	10 1/4	10 3/4	11 1/8	11 1/2	11 7/8	12 1/4	12 3/4	13	13 1/2	14 1/4	14 1/2	14 3/4	15
	cm	24	25	26	27	28	29	30	31	32	33	34	35	36	37	38
11	inches	9 7/8	10 1/4	10 3/4	11 1/8	11 1/2	11 7/8	12 1/4	12 3/4	13 1/2	14 1/2	15	15 3/4	16 1/2	17 1/4	18 1/4
	cm	25	26	27	28	29	30	31	32	34	36	38	40	42	44	46

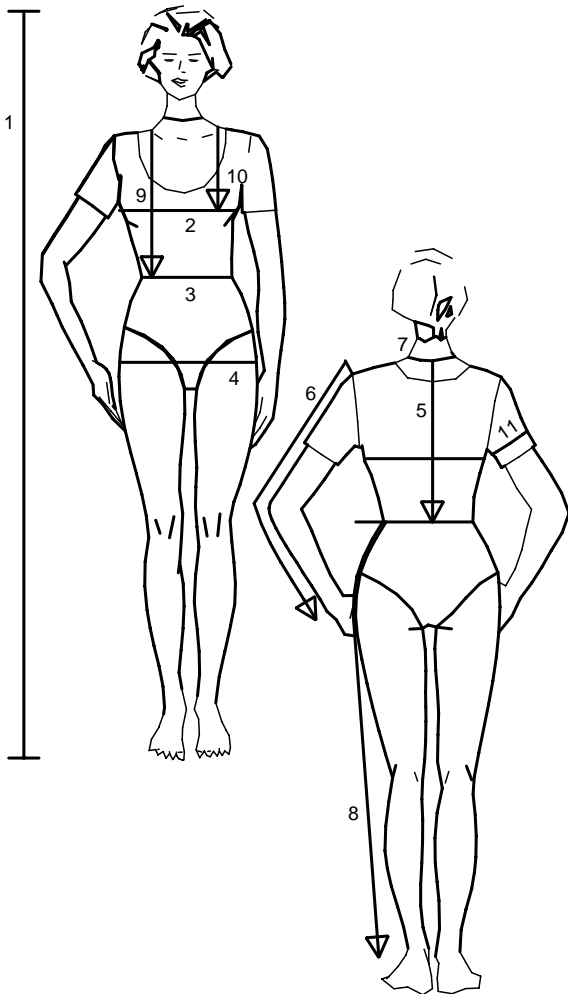

englisch

1. Height
2. Bust
3. Waist
4. Hip
5. Back length
6. Sleeve length
7. Neck width
8. Side leg length
9. Front waist length
10. Bust point
11. Upper arm circumf.

For dresses, blouses, coats and jackets select size according to bust measurement, for trousers and skirts according to hip measurement!

All burda patterns are prepared with ease allowance appropriate for style in question.

français

1. Stature
2. Tour de poitrine
3. Tour de taille
4. Tour des hanches
5. Long. du dos
6. Longueur de manche
7. Tour de cou
8. Long. côté pantalon
9. Long. taille devant
10. Profondeur de poitrine
11. Tour du bras

Robes, corsages, manteaux et vestes seront choisis d'après votre tour de poitrine les pantalons et les jupes d'après votre tour de hanches!

Tous les patrons sont établis avec l'aisance nécessaire selon le genre du modèle.

español

1. Estatura
2. Contorno busto
3. Contorno cintura
4. Contorno cadera
5. Largo espalda
6. Largo manga
7. Contorno cuello
8. Largo lateral del pantalón
9. Altura talle delantero
10. Altura de pecho
11. Cont. de brazo

La talla para los vestidos, blusas, abrigos y chaquetas, se determina de acuerdo con el contorno del busto. Los pantalones y las faldas, de acuerdo con el contorno de las caderas.

En el patrón-Burda se incluyen los márgenes para la holgura necesaria.

4d

5d

6e

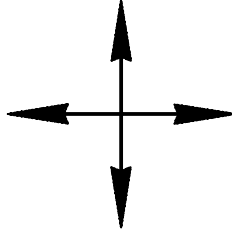

FABRIC FOLD
PLIURE DU TISSU
CANTO DE DOBLEZ

4e

8a

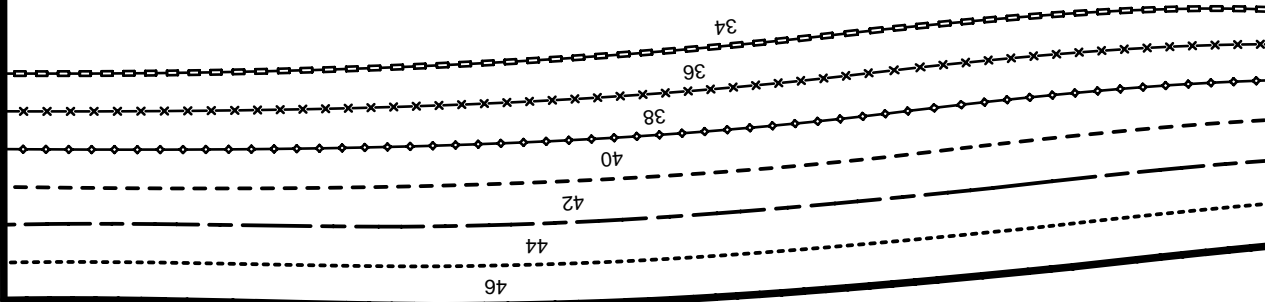

4
34

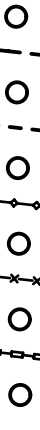

7a

6a



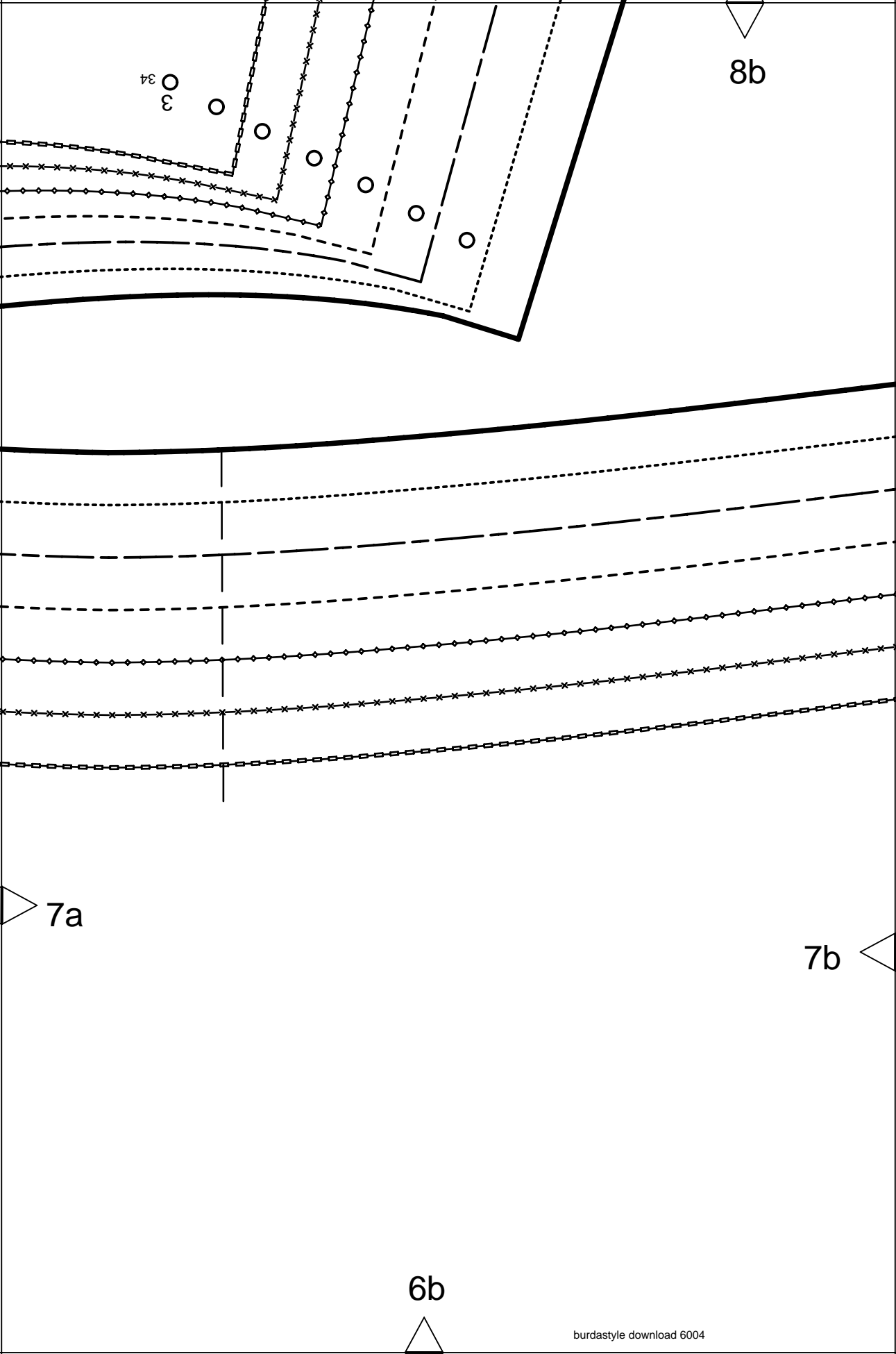

8b

3
34

7a

7b

6b

8c

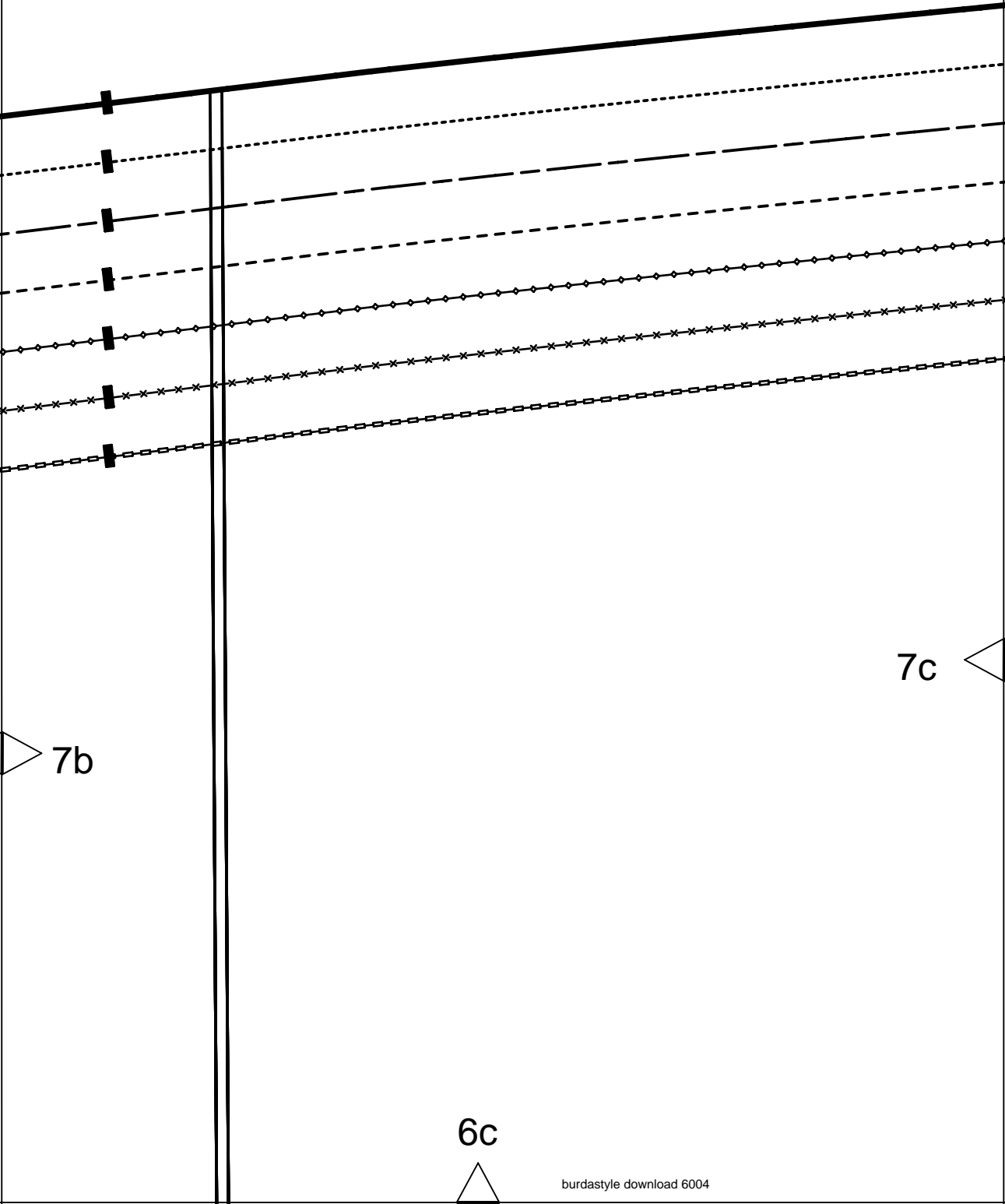

7b

7c

6c

8d

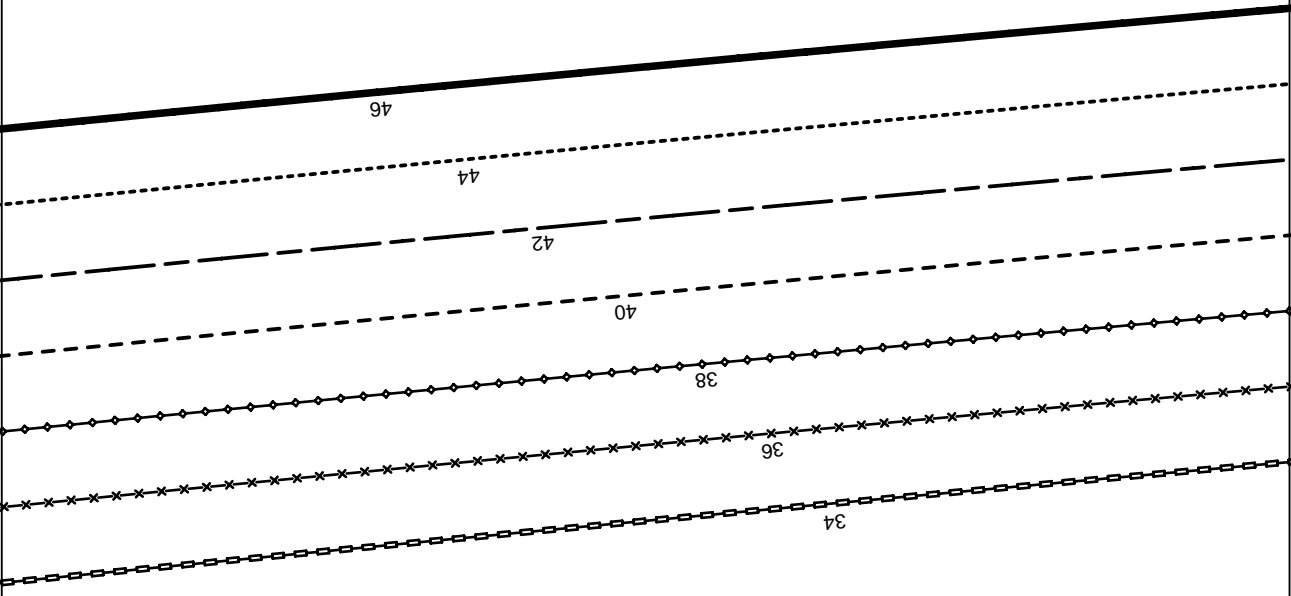

6d



7c

7d



7

TIE-BAND
BANDE A NOUER
LAZADA

FOLD

PLIURE
DOBLEZ



ON THE FOLD
DANS LA PLIURE DU TISSU
CON CANTO DOBLADO

5/8"
(1.5cm)

SEAM ALLOWANCE INCLUDED
AVEC VALEUR DE COUTURE
CON MARGEN DE COSTURA

6004

8e

6e

7d

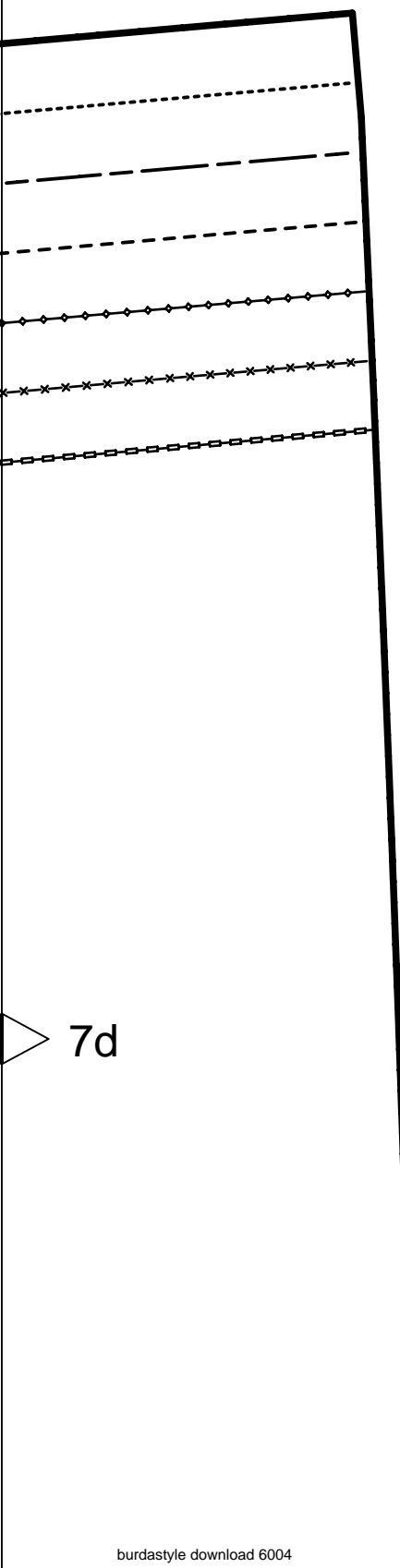

10a

WAIST
TAILLE
CINTURA

STRAIGHT GRAIN
DROIT FIL
SENTIDO HILO

9a

LENGTHEN OR SHORTEN HERE
RALLONGER OU RACCOURCIR ICI
ALARGAR O ACORTAR AQUI

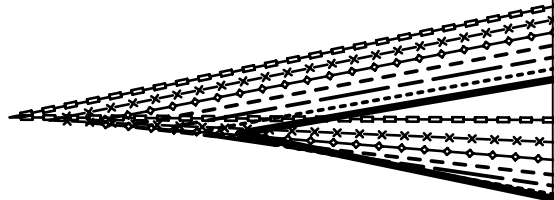

8a

FINISHED TOUR DE CONTORNO	BUST POITRINE BUSTO	SIZE
82cm	32	34 1/2"
86cm	34"	36 1/2"
90cm	35	38 1/2"
95cm	37	40 1/2"
99cm	39"	42 1/2"
104cm	41"	44 1/2"
108cm	42	46 1/2"

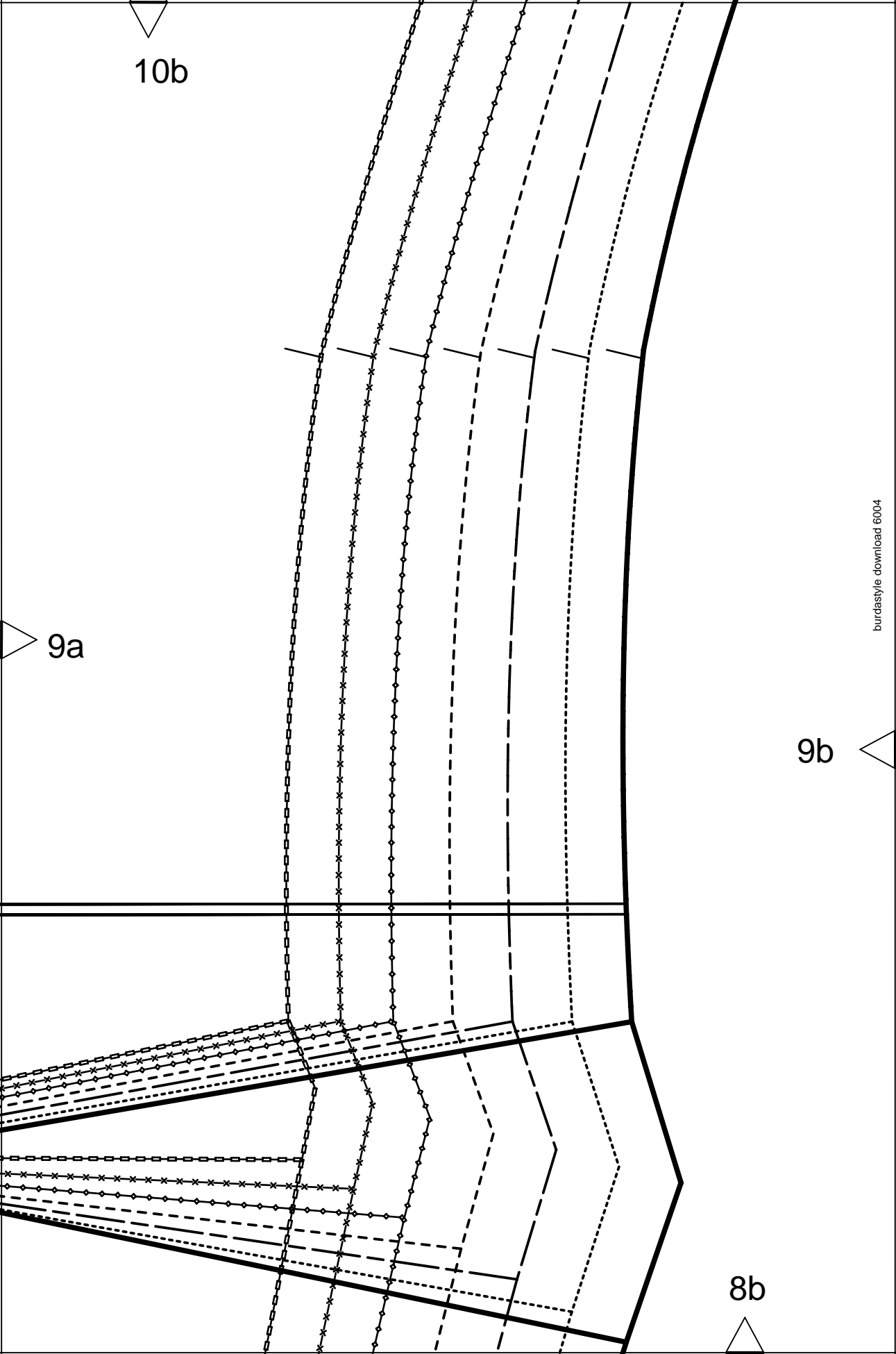

10c

34

46

Burda
STYLE
www.burdastyle.com

9b

4

BACK YOKE
EMPIECEMENT DOS
CANESU POST.



ON THE FOLD
DANS LA PLIURE DU TISSU
CON CANTO DOBLADO

5/8"
(1,5cm)

SEAM ALLOWANCE INCLUDED
AVEC VALEUR DE COUTURE
CON MARGEN DE COSTURA

6004

CENTER BACK FOLD STRAIGHT GRAIN
PLIURE DU TISSU MILIEU DOS DROIT FIL
CENTRO POSTERIOR DOBLEZ DIR-HILO



9c

8c

10d

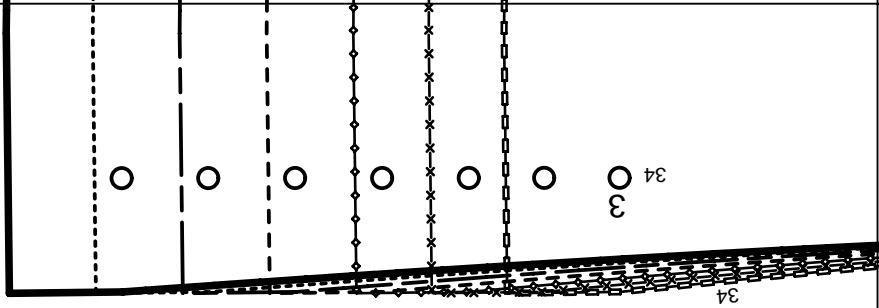

9d

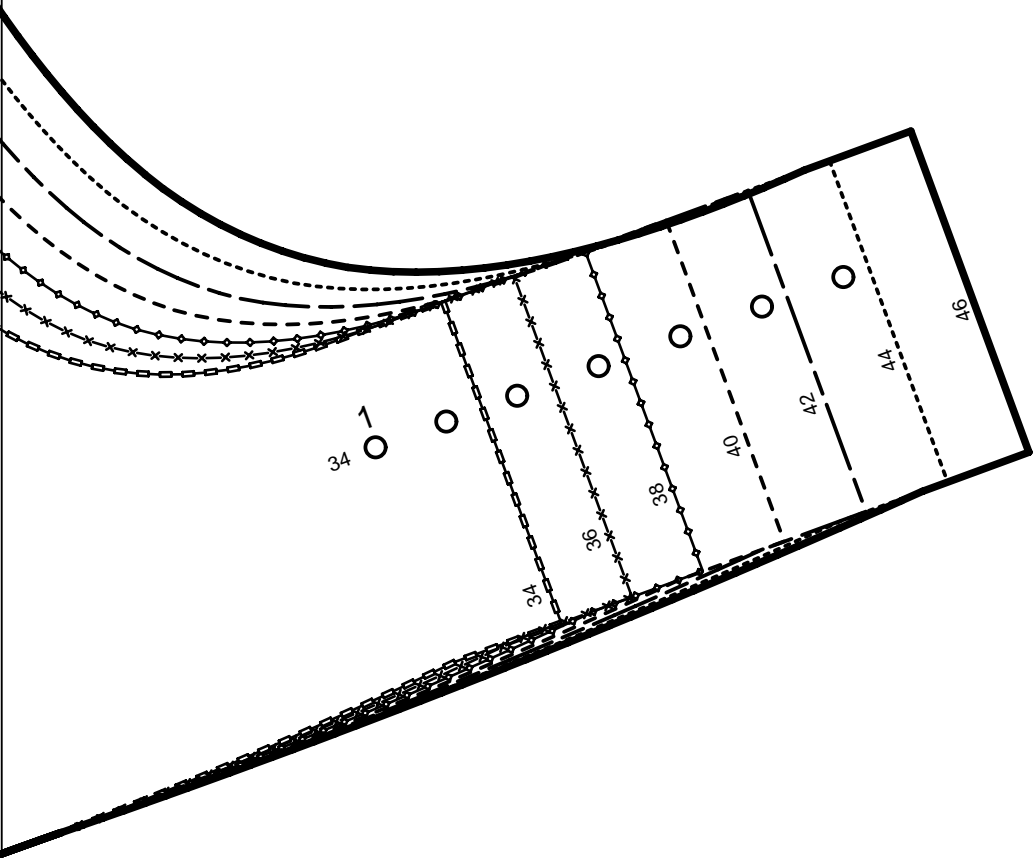

9c

8d

10e

46

44

42

40

38

36

34

9d



Burda
STYLE
www.burdastyle.com

8e



12a

11a



LENGTHEN OR SHORTEN HERE
RALLONGER OU RACCOURCIR ICI
ALARGAR O ACORTAR AQUI

CENTER FRONT FOLD, STRAIGHT GRAIN
MILIEU DEVANT PLIURE, DROIT FIL
MEDIO DELANTERO DOBLEZ SENT, HILO

10a



12b

11a

LEFT ZIPPER
FERM. A GLISS A GAUCHE
CREMALLERA IZQUIERDA

11b

10b

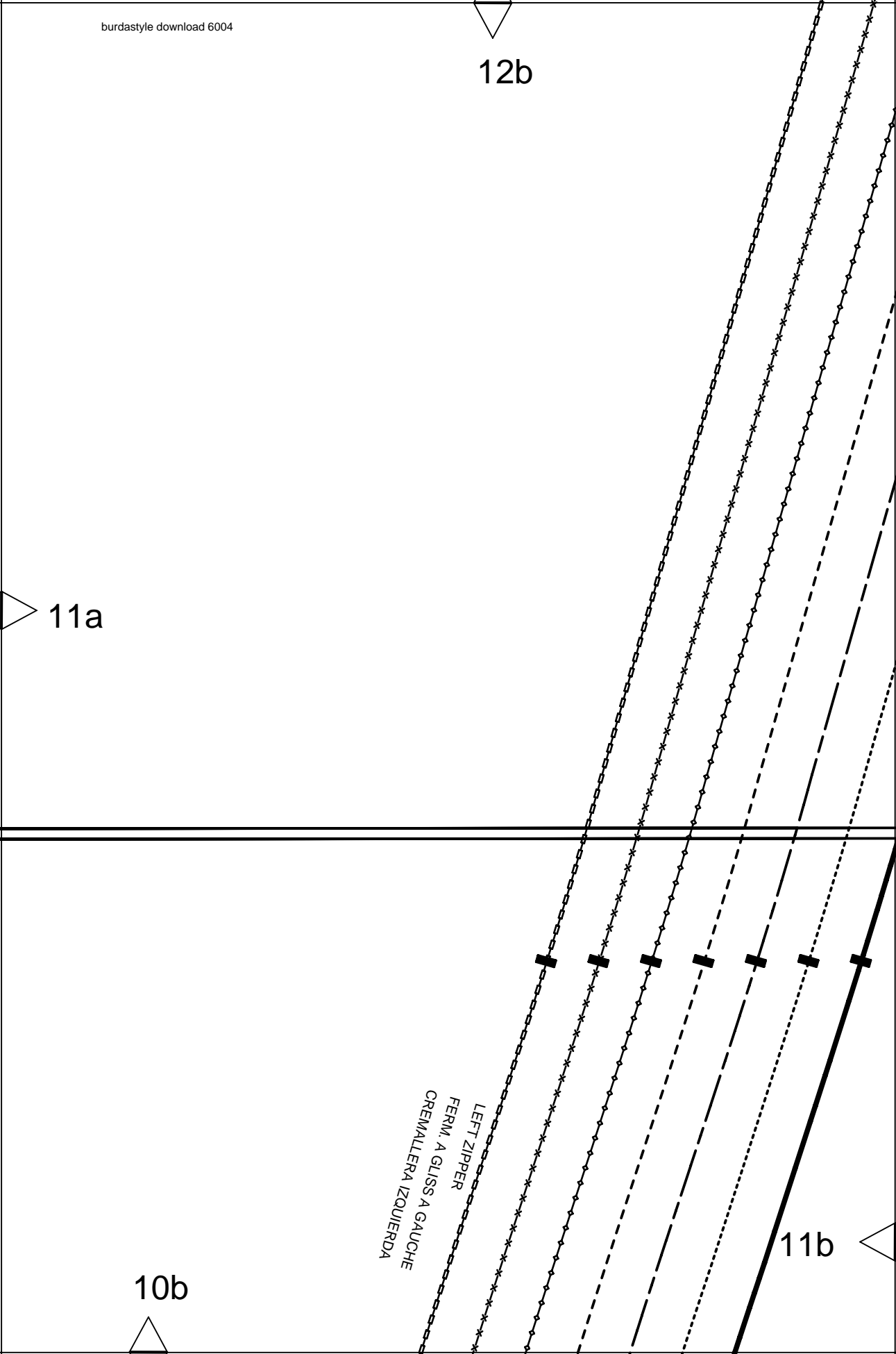

12c

Burda STYLE

www.burdastyle.com

11c

11b

10c

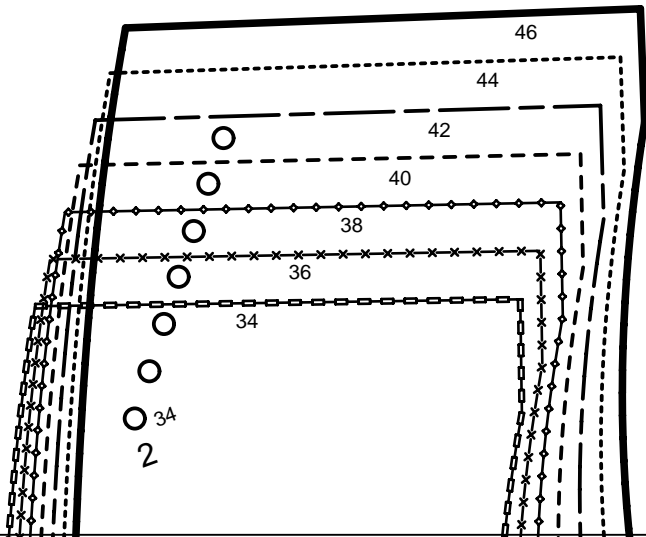

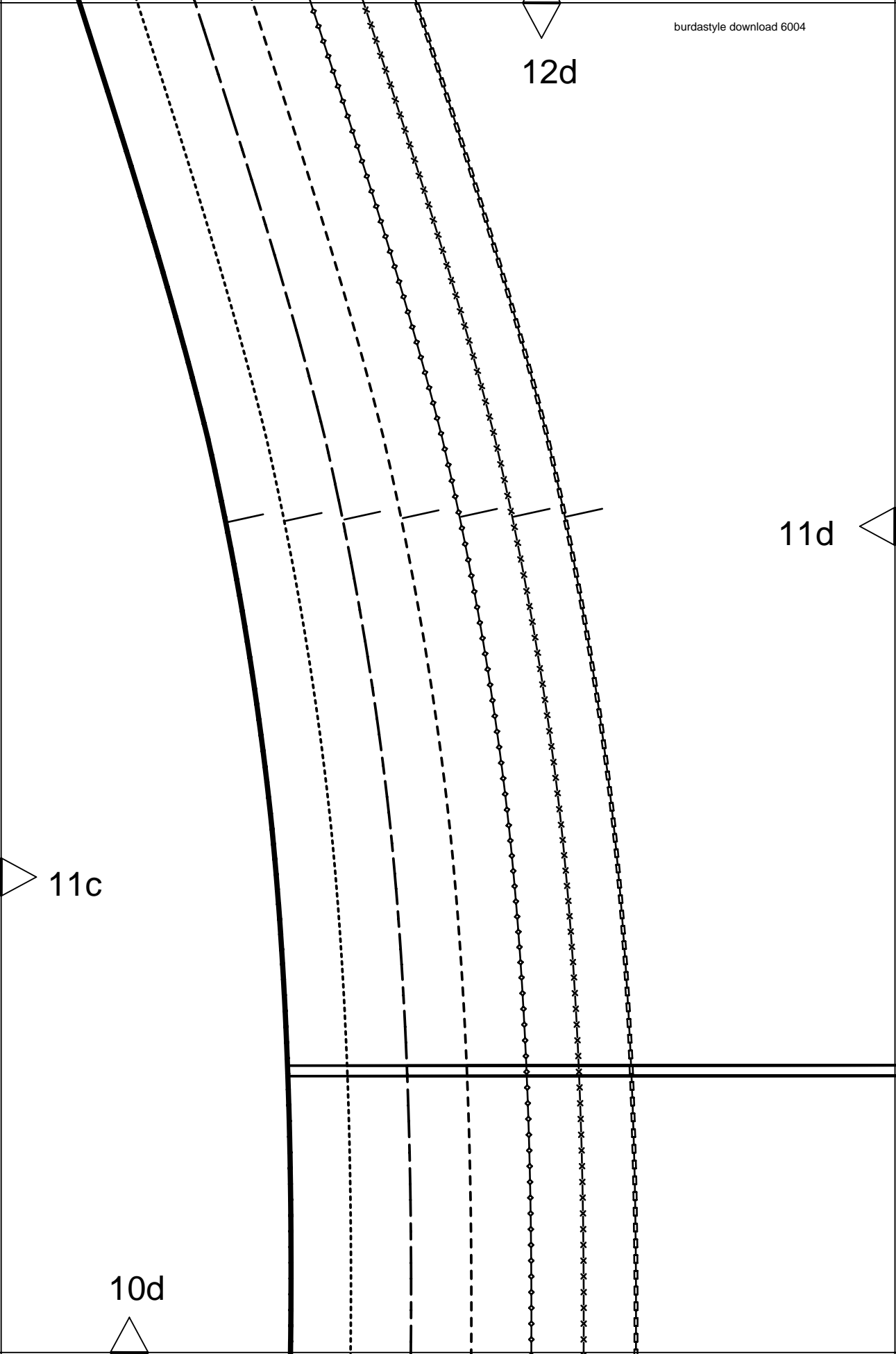

12e

WAIST
TAILLE
CINTURA

STRAIGHT GRAIN
DROIT FIL
SENTIDO HILO

11d

LENGTHEN OR SHORTEN HERE
RALLONGER OU RACCOURCIR ICI
ALARGAR O ACORTAR AQUI

10e



14a

STRAIGHT GRAIN
DROIT FIL
SENTIDO HILO

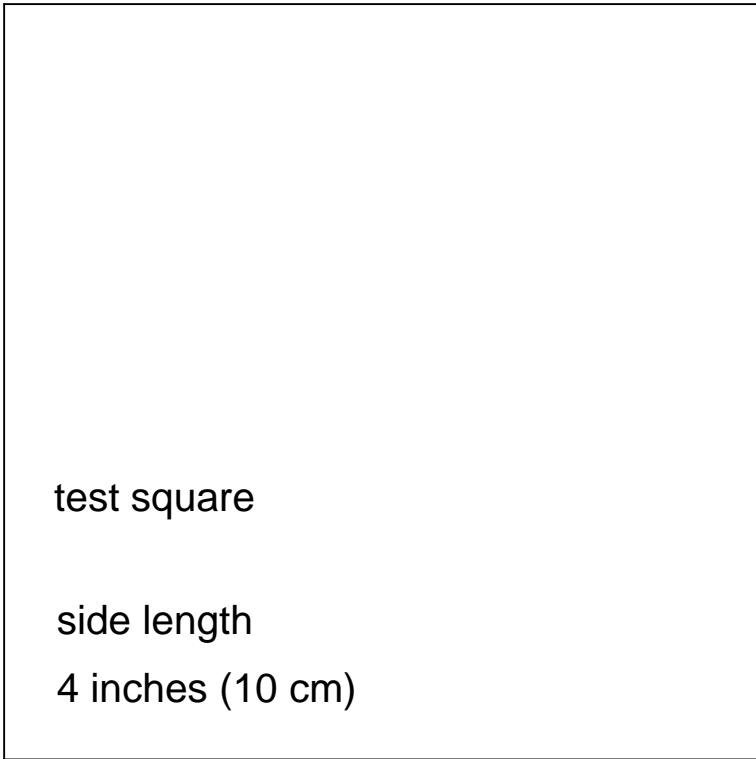

13a



12a



14b

13b

13a

Burda
STYLE
www.burdastyle.com

6004

SEAM ALLOWANCE INCLUDED
AVEC VALEUR DE COUTURE
CON MARGEN DE COSTURA (1.5cm)
5/8"

ON THE FOLD
DANS LA PLIURE DU TISSU
CON CANTO DOBLADO



ON THE FOLD

DELANTERO

DEVANT

FRONT

2

12b

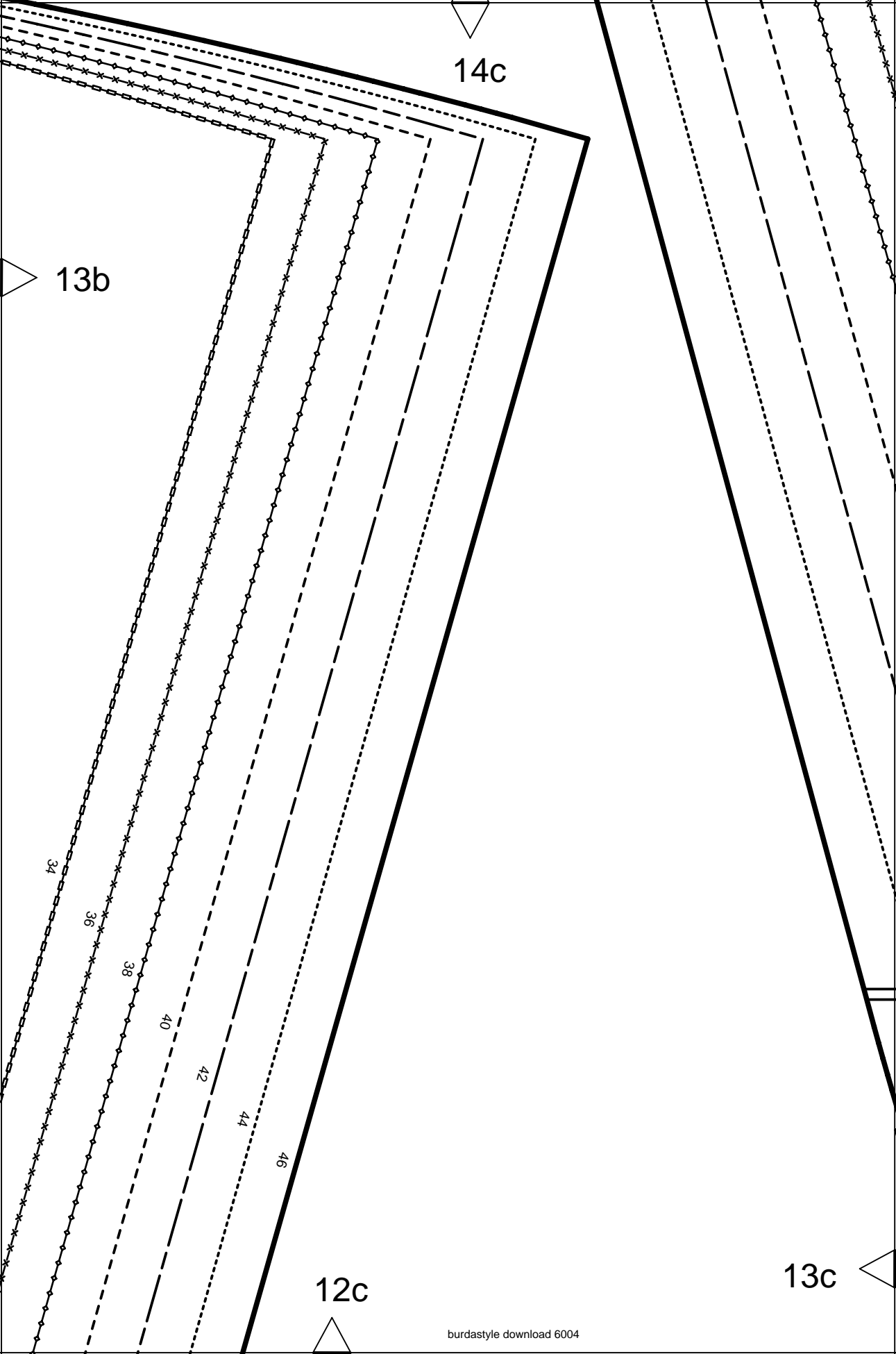

14c

13b

12c

13c

14d

13d

12d

13c

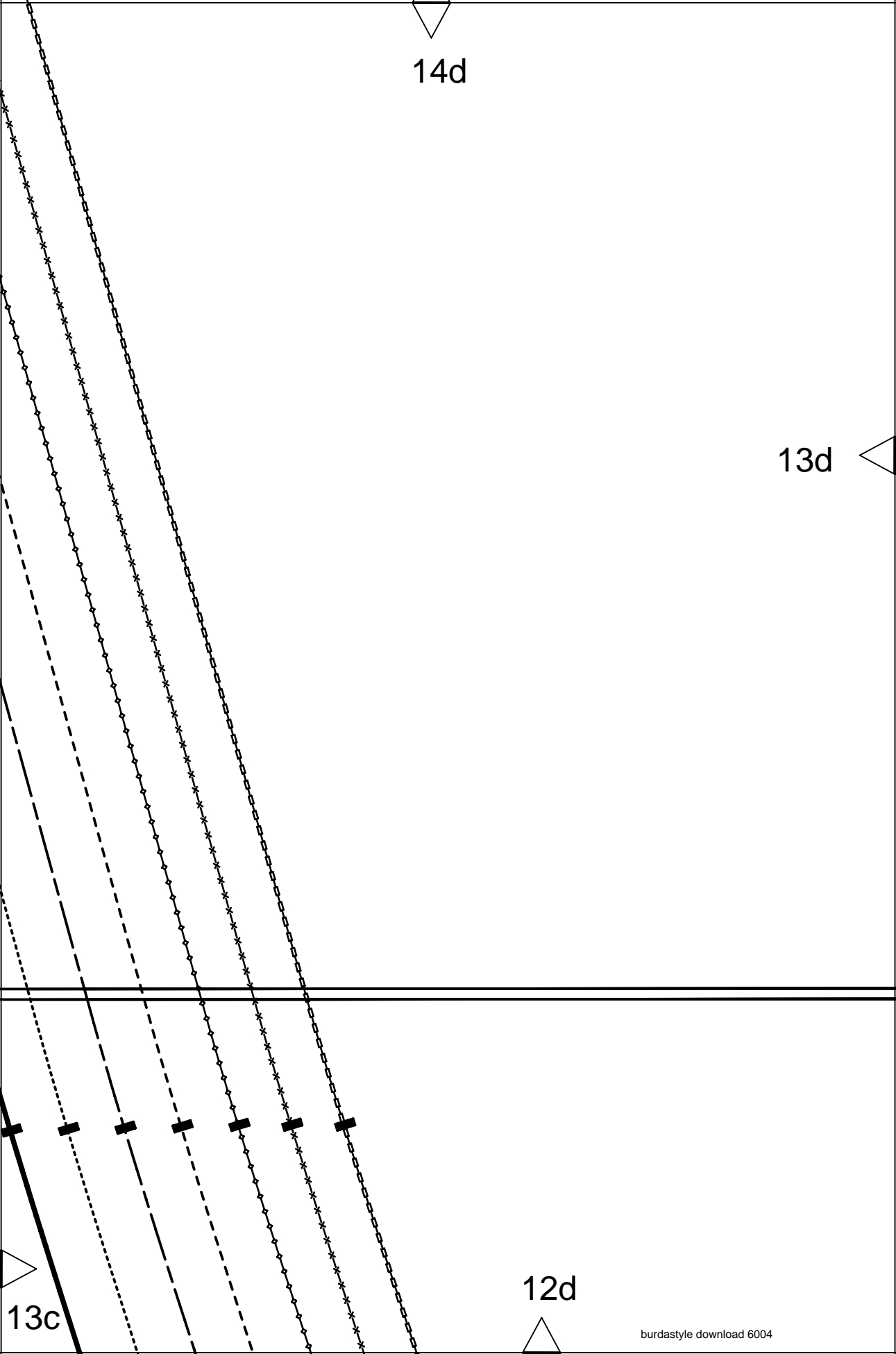

CENTER BACK FOLD STRAIGHT GRAIN
PLIURE DU TISSU MILIEU DOS DROIT FIL
CENTRO POSTERIOR DOBLEZ DIR.HILO



14e



13d

LENGTHEN OR SHORTEN HERE
RALLONGER OU RACCOURCIR ICI
ALARGAR O ACORTAR AQUI

12e



Burda STYLE

www.burdastyle.com

LEFT ZIPPER
FERM. A GLISS A GAUCHE
CREMALLERA IZQUIERDA

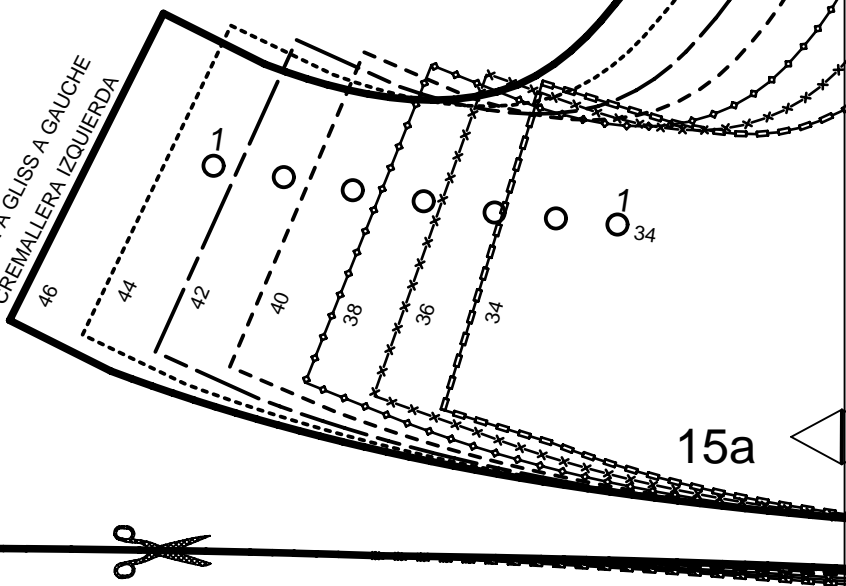

14a



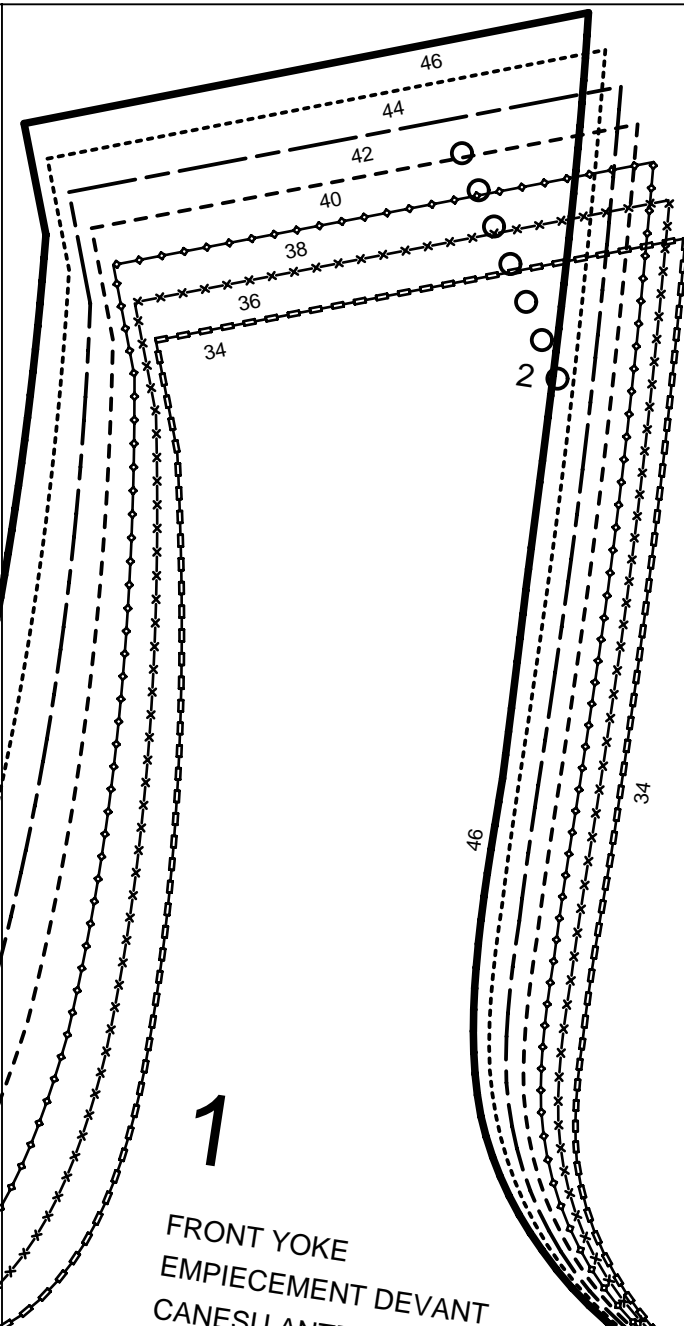

15b

1

FRONT YOKE
 EMPIECEMENT DEVANT
 CANESU ANTERIOR



2x ON THE FOLD
 DANS LA PLIURE DU TISSU
 CON CANTO DOBLADO

5/8"
 (1,5cm)

SEAM ALLOWANCE INCLUDED
 AVEC VALEUR DE COUTURE
 CON MARGEN DE COSTURA

STRAIGHT GRAIN
 DROIT FIL
 SENTIDO HILO



FABRIC FOLD
 PLIURE DU TISSU
 CANTO DE DOBLEZ
 CENTER FRONT
 MILIEU DEVANT
 CENTRO DELANTERO

15a

6004

14b

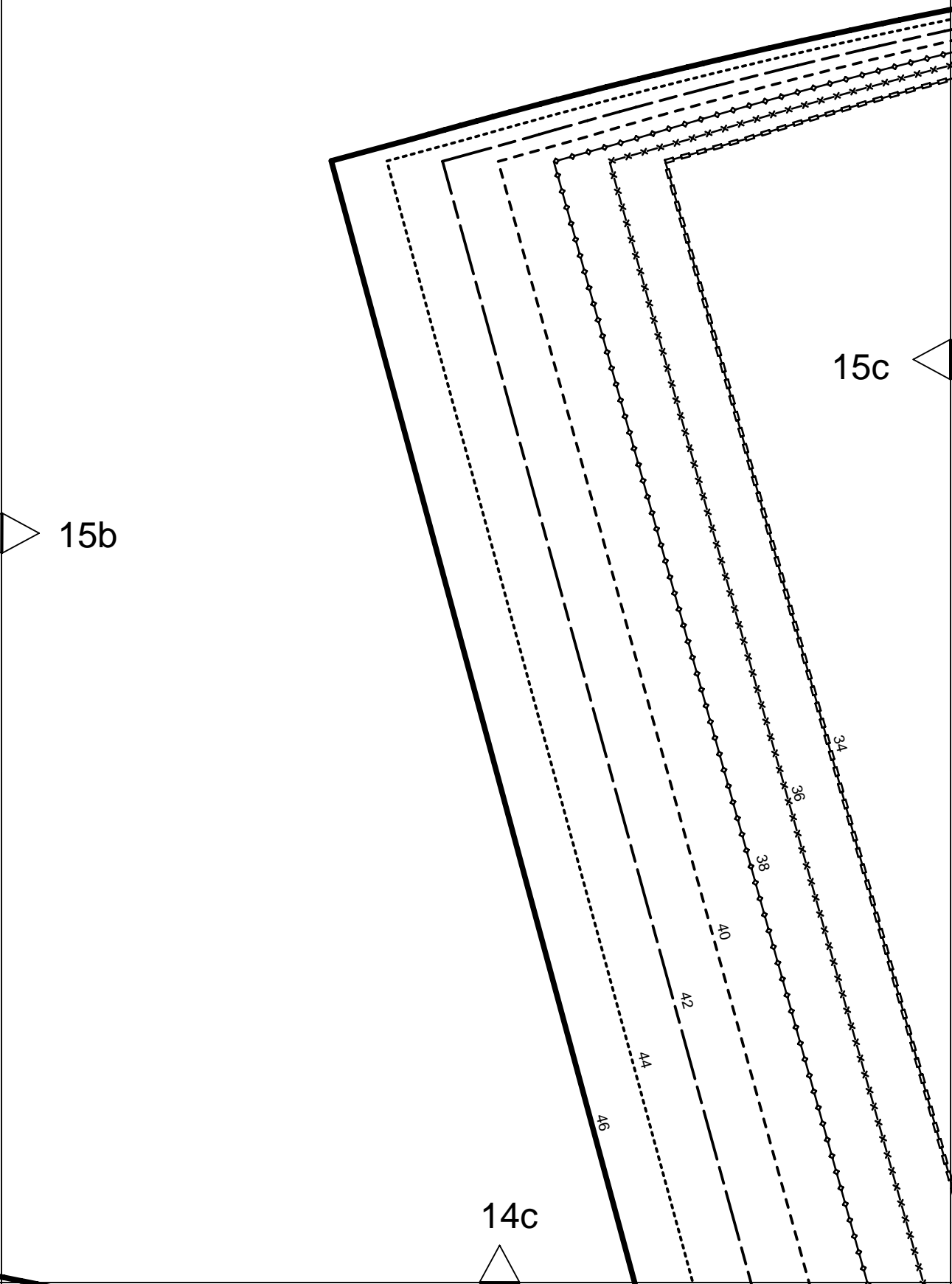

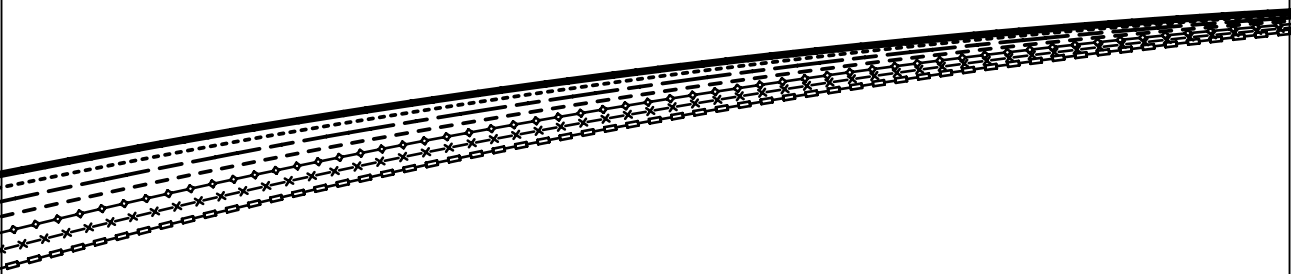

15c

15d

14d

STRAIGHT GRAIN
DROIT FIL
SENTIDO HILO



www.burdastyle.com

Burda
STYLE

6004

SEAM ALLOWANCE INCLUDED
AVEC VALEUR DE COUTURE
CON MARGEN DE COSTURA

(1.5cm)

5/8"

ON THE FOLD
DANS LA PLIURE DU TISSU
CON CANTO DOBLADO



ESPALDA

DOS

BACK

5

14e



15d



PATTERN LAYOUTS

PLANS DE COUPE

PLANOS DE CORTE

FABRIC



TISSU

TELA

55" 140 CM

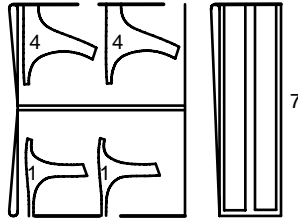

34-46

FABRIC



TISSU

TELA

55" 140 CM

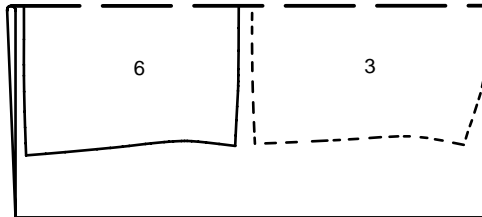

34-46

FABRIC



TISSU

TELA

55" 140 CM

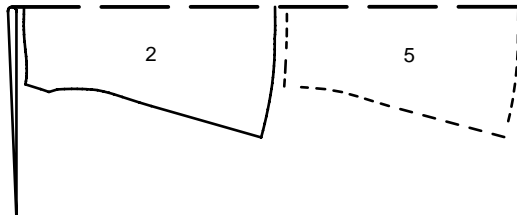

34-46